

All dimensions are shown in inches unless otherwise stated.

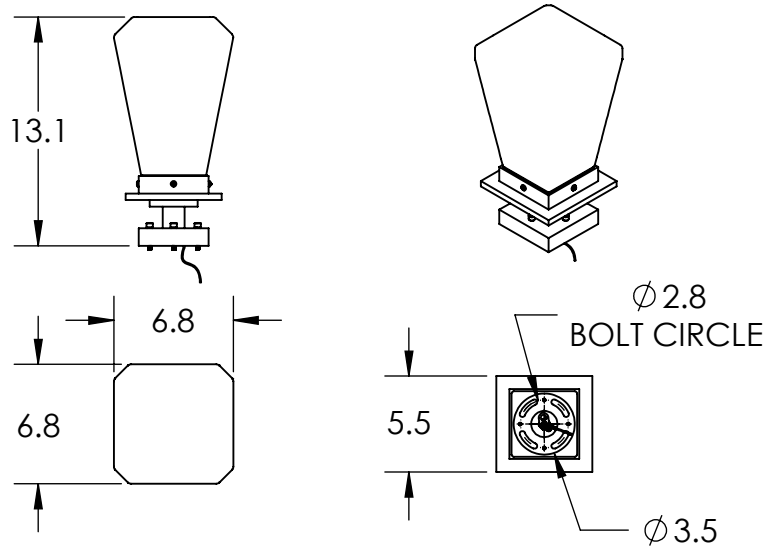

Mounting Method: Mounts Directly to Pier

PRODUCT DESCRIPTION

A fresh re-interpretation of an old-world lantern silhouette, the Beacon Pier Mount features a large artisan blown glass shade with a clear chilled texture. It is offered with both incandescent and AC LED lamping.

Choose from three AAMA 2604-rated finishes that provide long-lasting UV and corrosion resistance in coastal and other harsh climates. All Beacon lighting includes a lifetime warranty to the original purchaser.

PRODUCT SPECIFICATION

Construction: Aluminum Body With Blown Glass

Finish Options: **AG** **SB** **TB**

Glass Types: **HC**

Suspension Method: Pier Mount

Weight(lbs.): 8

UL Rating: Wet

Top Diffuser: Closed Glass

Bottom Diffuser: Closed

Light Source: LED

Electrical Qty: 1

Wattage (Watts): 4.5

Voltage (Volts): 120

Source Lumens: 400

Dimming: ELV to 1%

CCT: 3000K

Driver Quantity & Location: 1, in Pier

CRI: 93+

Power Factor: >0.9

SCAN FOR MORE INFORMATION

Notes:

GENERAL NOTES:

Visit studio.hammerton.com to read about our Lifetime Limited Warranty.

All Hammerton fixtures are handcrafted by artisans. Subtle imperfections reflect the mark of the artisan and should be expected in any handcrafted product. Dimensions may vary up to 7/8".

Rev © 6/18/2021